



TOPSTAR TECHNOLOGY INDUSTRIAL CO., LIMITED

产品规格书

Product Specification Sheet

TOP-SFP+-10G-LRM

RoHS Compliant 10Gb/s SFP+ 1310nm 220M Optical Transceiver



E-mail : csale@topsfp.com





PRODUCT FEATURES

- 10Gb/s serial optical interface compliant to 802.3aq 10GBASE-LRM
- 1310nm DFB transmitter, PIN photo-detector
- Duplex LC connector
- Metal enclosure, for lower EMI
- Electrical interface compliant to SFF-8431
- Specifications for 10 Gigabit “SFP+”
- 2-wire interface for management specifications
- Compliant with SFF 8472
- Single 3.3V power supply
- 220M legacy OM1 MMF Transmission
- Case operating temperature range:-5°C to 70°C

APPLICATIONS

- 10GBASE-LRM 10G Ethernet

STANDARD

- Compliant with SFF-8472 SFP+ MSA.
- Compliant to SFP+ SFF-8431 and SFF-8432.
- Compliant to 802.3ae 10GBASE-LRM.
- RoHS Compliant.

**I .Absolute Maximum Ratings**

Parameter	Symbo	Min	Typ	Max	Unit	Ref.
Maximum Supply Voltage	Vcc	3.14		3.46	V	
Storage Temperature	TS	-40		85	°C	
Case Operating Temperature	Tcase	-5		70	°C	

II . Electrical Characteristics (Tcase = -5 to 70°C, VCC = 3.14 to 3.46Volts)

Parameter	Symbol	Min	Typ	Max	Unit	Ref.
Supply Voltage	Vcc	3.14	3.3	3.46	V	
Supply Current	Icc			330	mA	
Transmitter						
Input differential impedance	Rin		100		Ω	1
Single ended data input swing	Vin,pp	180		700	mV	
Transmit Disable Voltage	VD	Vcc-		Vcc	V	
Transmit Enable Voltage	VEN	Vee		Vee+ 0.8	V	2
Transmit Disable Assert Time				10	us	
Receiver						
Differential data output swing	Vout,pp	300		850	mV	3
Data output rise time	tr	30			ps	4
Data output fall time	tf	30			ps	4
LOS Fault	VLOS fault	Vcc-		VccHOS	V	5
LOS Normal	VLOS	Vee		Vee+0.8	V	5
Power Supply Rejection	PSR	100			mVpp	6

Notes:

1. Connected directly to TX data input pins. AC coupled thereafter.
2. Or open circuit.
3. Into 100 ohms differential termination.
4. These are unfiltered 20-80% values
5. Loss Of Signal is LVTTTL. Logic 0 indicates normal operation; logic 1 indicates no signal detected.
6. Receiver sensitivity is compliant with power supply sinusoidal modulation of 20 Hz to 1.5 MHz up to specified value applied through the recommended power supply filtering network.



III. Optical Characteristics (Tcase = -5 to 70°C, VCC = 3.14 to 3.46 Volts)

Parameter	Symbo	Min	Typ	Max	Unit	Ref.
Transmitter						
Average Launch Power	P _{OUT}	-6.5		0.5	dBm	1
Optical Wavelength	λ	1290	1310	1330	nm	
Optical Extinction Ratio	ER	3.5			dB	
Side Mode Supression Ratio	SMSR	30			dB	
RIN	RIN			-128	dB/Hz	
Output Eye Mask	Compliant with IEEE 0802.3ae					
Receiver						
Receiver Sensitivity@10.3125G	Sen			-10	dBm	2
Input Saturation Power	Psat	1.5			dBm	3
Wavelength Range	λ _C	1260		1350	nm	
LOS De -Assert	LOSD			-14	dBm	
LOS Assert	LOSA	-30			dBm	
LOS Hysteresis		0.5			dB	

Notes:

1. Average power figures are informative only, per IEEE802.3aq
2. Conditions of stressed receiver tests per IEEE802.3aq.
3. Receiver overload specified in OMA and under the worst comprehensive stressed condition.

IV. Pin Descriptions

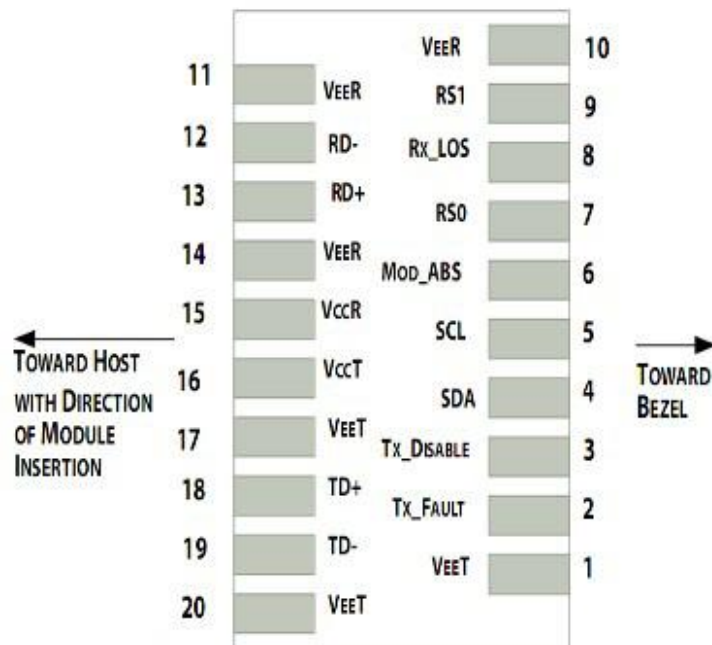

Pin out of Connector Block on Host Board



Pin	Symbol	Name/Description	Ref.
1	V _{EET}	Transmitter Ground (Common with Receiver Ground)	1
2	T _{FAULT}	Transmitter Fault.	2
3	T _{DIS}	Transmitter Disable. Laser output disabled on high or open.	3
4	SDA	2-wire Serial Interface Data Line	4
5	SCL	2-wire Serial Interface Clock Line	4
6	MOD_ABS	Module Absent. Grounded within the module	4
7	RS0	Rate Select 0	5
8	LOS	Loss of Signal indication. Logic 0 indicates normal operation.	6
9	RS1	No connection required	1
10	V _{EER}	Receiver Ground (Common with Transmitter Ground)	1
11	V _{EER}	Receiver Ground (Common with Transmitter Ground)	1
12	RD-	Receiver Inverted DATA out. AC Coupled	
13	RD+	Receiver Non-inverted DATA out. AC Coupled	
14	V _{EER}	Receiver Ground (Common with Transmitter Ground)	1
15	V _{CCR}	Receiver Power Supply	
16	V _{CCT}	Transmitter Power Supply	
17	V _{EET}	Transmitter Ground (Common with Receiver Ground)	1
18	TD+	Transmitter Non-Inverted DATA in. AC Coupled.	
19	TD-	Transmitter Inverted DATA in. AC Coupled.	
20	V _{EET}	Transmitter Ground (Common with Receiver Ground)	1

Notes:

1. Circuit ground is internally isolated from chassis ground.
2. T_{FAULT} is an open collector/drain output, which should be pulled up with a 4.7k – 10k Ohms resistor on the host board if intended for use. Pull up voltage should be between 2.0V to V_{cc} + 0.3V. A high output indicates a transmitter fault caused by either the TX bias current or the TX output power exceeding the preset alarm thresholds. A low output indicates normal operation. In the low state, the output is pulled to <0.8V.
3. Laser output disabled on T_{DIS} >2.0V or open, enabled on T_{DIS} <0.8V.
4. Should be pulled up with 4.7kΩ- 10kΩ host board to a voltage between 2.0V and 3.6V. MOD_ABS pulls line low to indicate module is plugged in.
5. Internally pulled down per SFF-8431 Rev 4.1.



6. LOS is open collector output. It should be pulled up with $4.7k\Omega - 10k\Omega$ on host board to a voltage between 2.0V and 3.6V. Logic 0 indicates normal operation; logic 1 indicates loss of signal.

V. Digital Diagnostic Functions

TOPSTAR TOP-SFP+-10G-LRM transceivers support the 2-wire serial communication protocol as defined in the SFP MSA1.

The standard SFP serial ID provides access to identification information that describes the transceiver's capabilities, standard interfaces, manufacturer, and other information.

Additionally, TOPSTAR SFP+ transceivers provide a unique enhanced digital diagnostic monitoring interface, which allows real-time access to device operating parameters such as transceiver temperature, laser bias current, transmitted optical power, received optical power and transceiver supply voltage. It also defines a sophisticated system of alarm and warning flags, which alerts end-users when particular operating parameters are outside of a factory set normal range.

The SFP MSA defines a 256-byte memory map in EEPROM that is accessible over a 2-wire serial interface at the 8 bit address 1010000X (A0h). The digital diagnostic monitoring interface makes use of the 8 bit address 1010001X (A2h), so the originally defined serial ID memory map remains unchanged.

The operating and diagnostics information is monitored and reported by a Digital Diagnostics Transceiver Controller (DDTC) inside the transceiver, which is accessed through a 2-wire serial interface. When the serial protocol is activated, the serial clock signal (SCL, Mod Def 1) is generated by the host. The positive edge clocks data into the SFP transceiver into those segments of the E2PROM that are not write-protected. The negative edge clocks data from the SFP transceiver. The serial data signal (SDA, Mod Def 2) is bi-directional for serial data transfer. The host uses SDA in conjunction with SCL to mark the start and end of serial protocol activation. The memories are organized as a series of 8-bit data words that can be addressed individually or sequentially.



VI. Host - Transceiver Interface Block Diagram

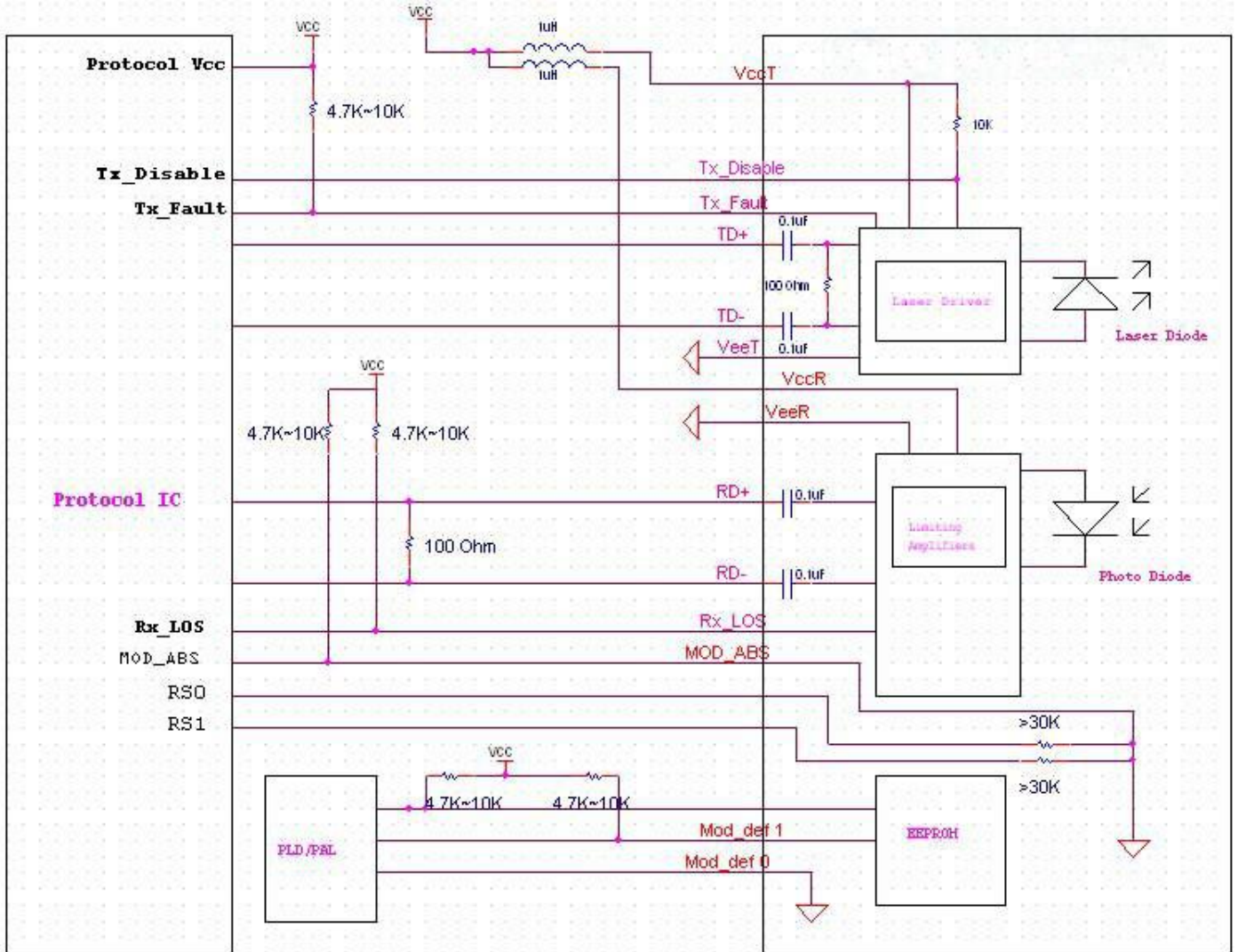



VII. Outline Dimensions

Comply to SFF-8432 rev. 5.0, the improved Pluggable form factor specification.

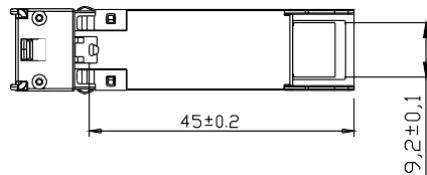
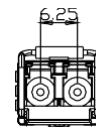
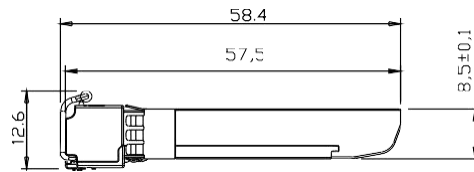
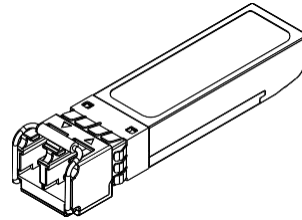
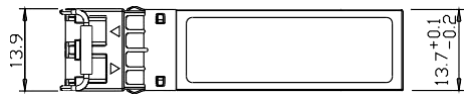

Units in mm

Ordering Information

Part Number	Description
TOP-SFP-10G-SR	SFP+ PLUS, 10.3125Gbps, 850nm, 300M, 0~70°C, with DDM
TOP-SFP-10G-LR	SFP+ PLUS, 10.3125Gbps, 1310nm, 10KM, 0~70°C, with DDM
TOP-SFP-10G-LR SDH	SFP+ PLUS, 10.3125Gbps, 1310nm, 10KM, for SDH, 0~70°C, with DDM
TOP-SFP-10G-ER	SFP+ PLUS, 10.3125Gbps, 1550nm, 40KM, 0~70°C, with DDM
TOP-SFP-10G-ZR	SFP+ PLUS, 10.3125Gbps, 1550nm, 80KM, 0~70°C, with DDM



TOPSTAR TECHNOLOGY INDUSTRIAL CO., LIMITED

Topstar Technology Industrial Co., Ltd

Add: F5, Rongcheng Building, 28 Yayuan Road Wuhe Community, BanTian Street, Shenzhen, China

Tel: +86 755 8255 2969 Email:lisa@topsfp.com

Skype: lisalin6565 Whatsapp: +86 13798265065

Wechat: 251081707

Facebook and Linked in: Topstar Technology Industrial Co., Ltd

